

LED LAMP CLUSTER

BL-CS21AR2G1B1

Features:

- Square LED lamp cluster
- 21mm*21mm
- High visibility
- Emitting Color: red,green,blue
- No of Built-in 5mm LED Lamps :
- Ultra orange - 2pcs,green – 1pcs ,blue – 1pcs.
- Waterproof Package With Hood Suitable
- For Outdoor and Indoor Information Boards



■ Selection Guide

Part No.	Description
BL-CS21AR2G1B1	21mm square Lamp cluster 2 red ,1 green,1 blue,square packed

■ Description:

- Color Code & Chip characteristics: (Test Condition: IF=20mA)

Part No.	Built-in Lamp Package	Built-in Lamp Part No. BL-	Chip		Lens Appearance	Electro-optical Data(At 20mA)			Viewing Angle 2 θ 1/2 (deg)
			Material/ Emitted Color	Peak Wave Length λ_p (nm)		Vf (V)		Iv (mcd)	
						Typ	Max		
BL-CS21A R2G1B1	4x5x7mm 1.0" Lead Oval	L563UEC	AlGaInP/ Ultra Orange	630	Water clear	2.10	2.50	750	X-X 45 Y-Y 25
		L563UGC	AlGaInP/ Ultra Green	574	Water clear	2.20	2.50	600	
		L563UBC	GaN/SiC Blue	430	Water clear	3.10	4.20	800	

Notes:

1. θ 1/2 Is the angle from optical centerline where the luminous intensity is 1/2 the optical centerline value.

■ Absolute Maximum Rating (Each Lamp, Ta=25°C Derate above 25°C)

Characteristic	Symbol	Ultra Orang	Ultra Green	Ultra Blue	Unit
Spectral Line Half width	$\Delta\lambda$	17	30	30	nm
Pulse Forward Current	IFp	150	150	150	mA
DC Forward Current	IF	30	30	30	mA
Reverse Voltage	VR	5	5	5	V
Power Dissipature	PD	65	75	75	mW
Operating Temperature	Topr	-40°C-80°C			
Storage Temperature	Tstg	-40°C-85°C			
Lead Soldering Temperature		Max.260 \pm 5°C for 3 sec Max. (1.6mm from the base of the epoxy bulb)			

LED LAMP CLUSTER

BL-CS21AR2G1B1

■ Package configuration & Internal circuit diagram:

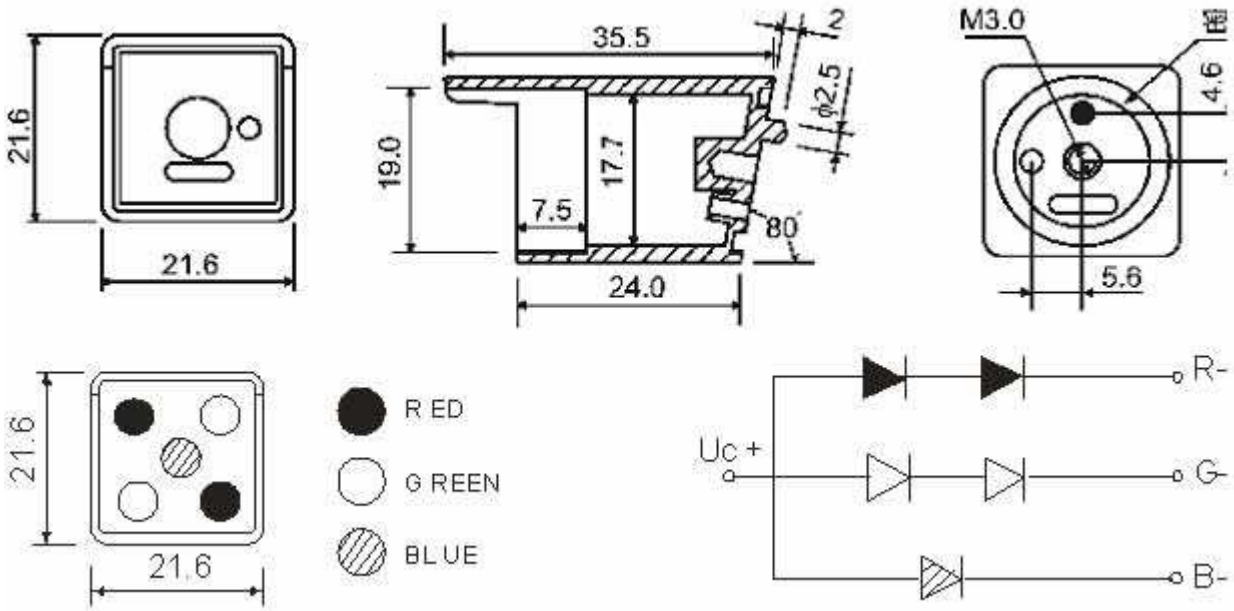

Notes:

- All dimensions are in millimeters (inches)
- Tolerance is $\pm 0.25(0.01)$ unless otherwise noted.
- Specifications are subject to change without notice.

LED LAMP CLUSTER

BL-CS21AR2G1B1

Typical electrical-optical characteristics curves:

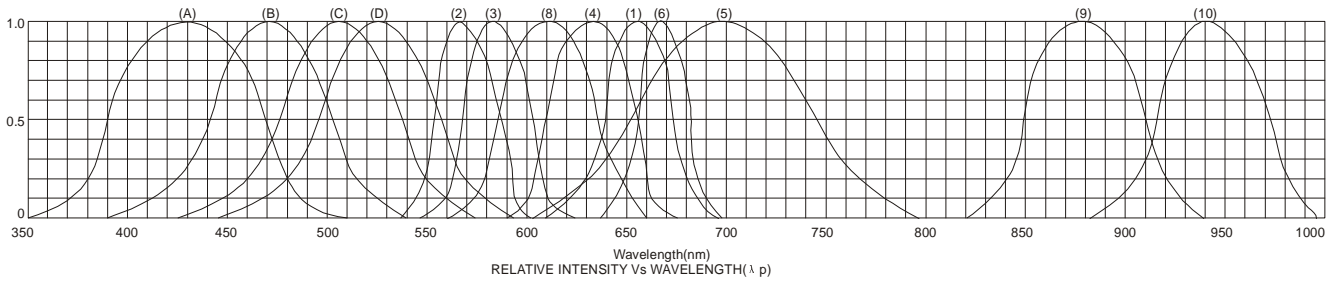

- (1) - GaAsP/GaAs 655nm/Red
- (2) - GaP 570nm/Yellow Green
- (3) - GaAsP/GaP 585nm/Yellow
- (4) - GaAsP/GaP 635nm/Orange & Hi-Eff Red
- (5) - GaP 700nm/Bright Red
- (6) - GaAlAs/GaAs 660nm/Super Red
- (8) - GaAsP/GaP 610nm/Super Red
- (9) - GaAlAs 880nm
- (10) - GaAs/GaAs & GaAlAs/GaAs 940nm
- (A) - GaN/SiC 430nm/Blue
- (B) - InGaN/SiC 470nm/Blue
- (C) - InGaN/SiC 505nm/Ultra Green
- (D) - InGaAl/SiC 525nm/Ultra Green

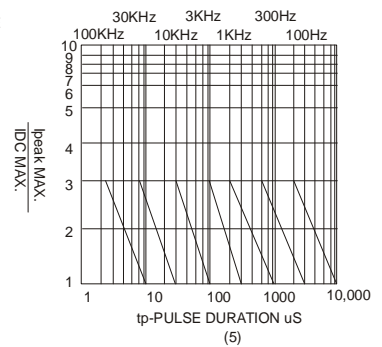
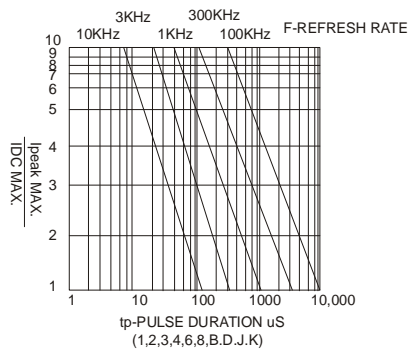
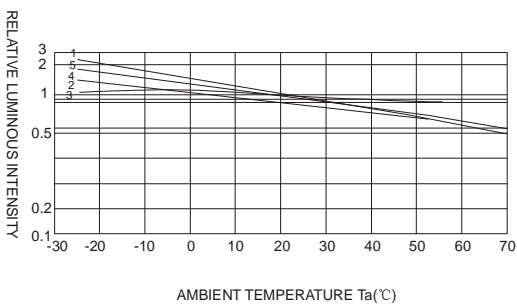
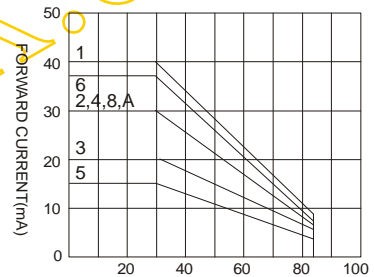
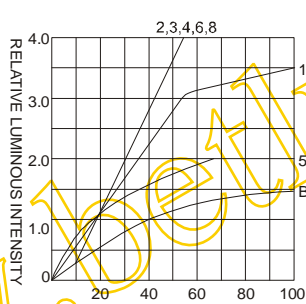
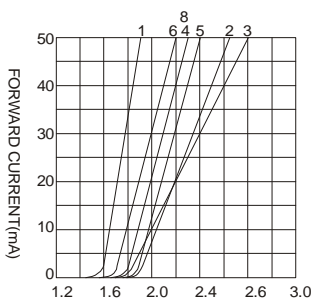

NOTE:25°C free air temperature unless otherwise specified